



AX R MP with NSPARC Multiphoton Confocal Microscope

AX R MP with NSPARC

Multiphoton Confocal Microscope



Shedding New Light On **MICROSCOPY**

LOOK DEEPER

Explore the hidden depths of whole organisms in panoramic views

Nikon's multiphoton confocal microscopes, which clearly visualize fine structures deep within living organisms, have evolved even further. The AX R MP is equipped with a high-speed resonant scanner with 2K resolution and can capture in a single scan dynamics that span a wide area with superior spatial and temporal resolution. In addition, the innovative NSPARC super-resolution detector utilizes a newly developed SPPC array detector to collect a two-dimensional image at each scanned point, achieving a significant improvement in resolution. This enables macro-to-micro imaging with a single microscope system.

For broad areas of research

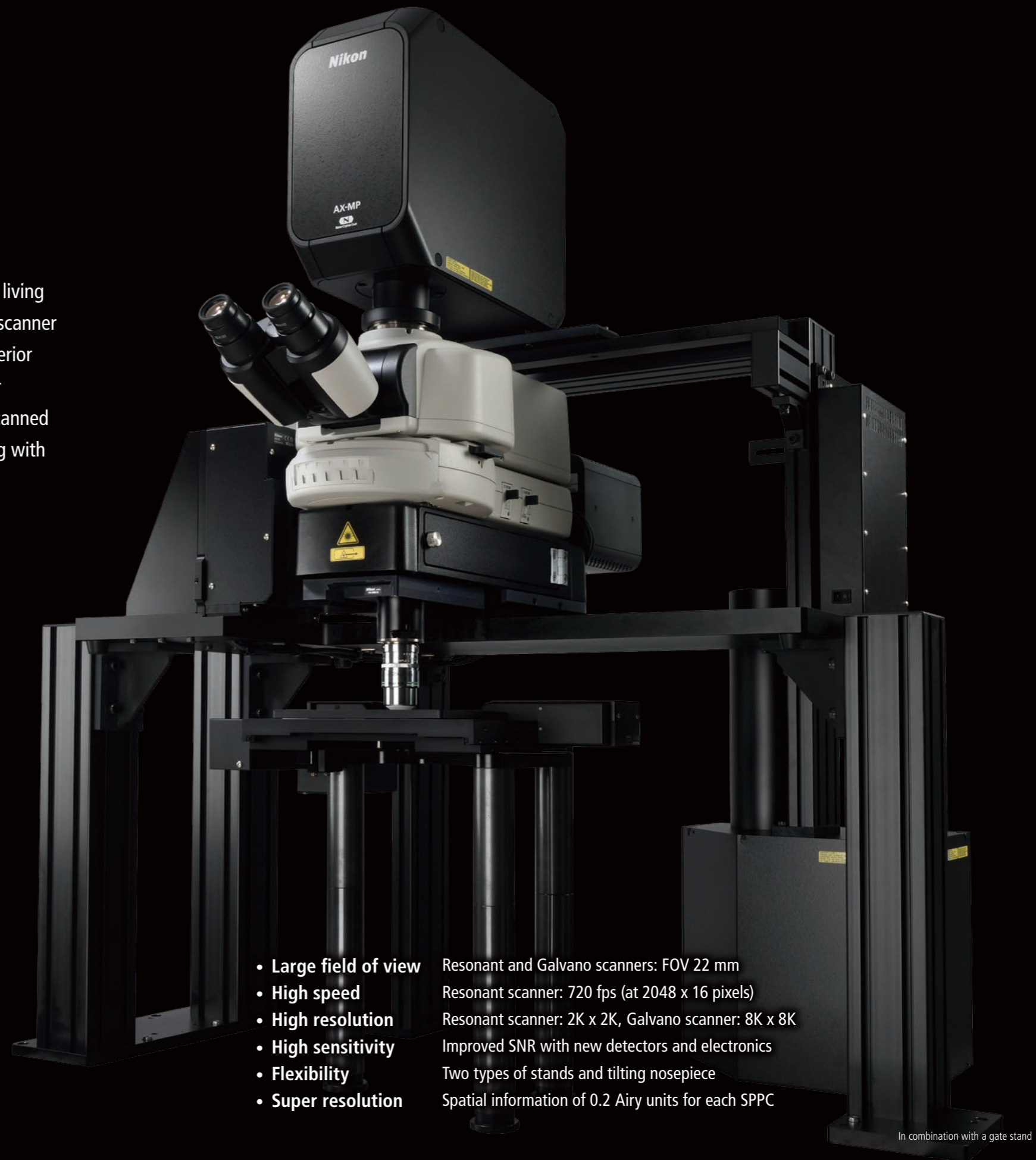
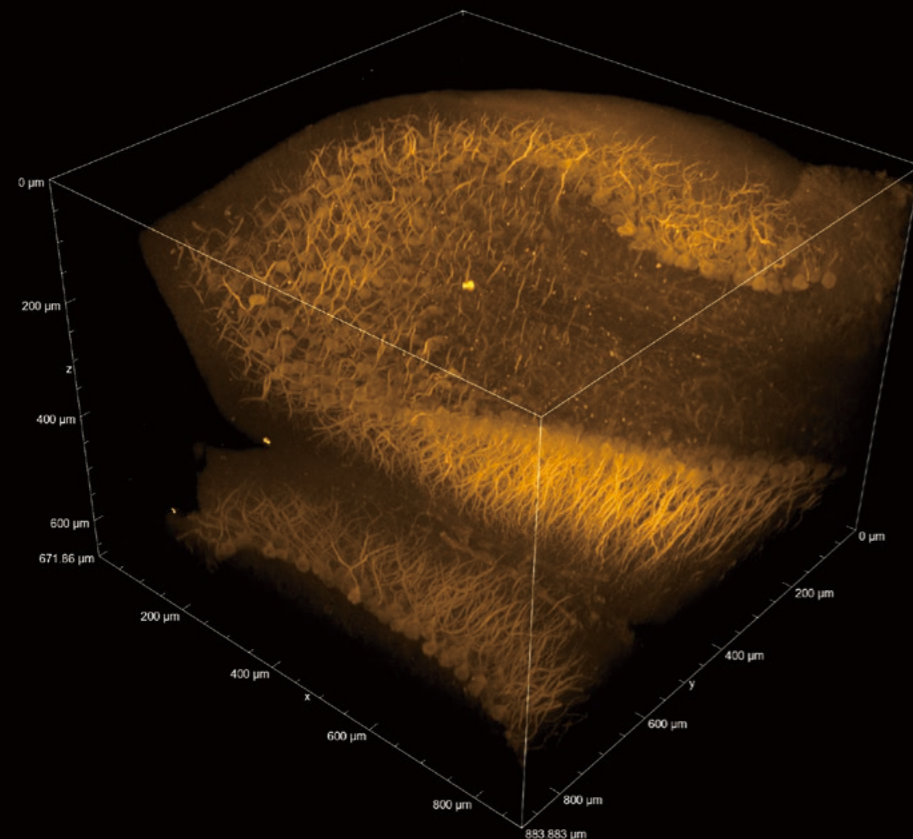

- Large field of view
- High speed
- High resolution
- High sensitivity
- Flexibility
- Super resolution

Resonant and Galvano scanners: FOV 22 mm
Resonant scanner: 720 fps (at 2048 x 16 pixels)
Resonant scanner: 2K x 2K, Galvano scanner: 8K x 8K
Improved SNR with new detectors and electronics
Two types of stands and tilting nosepiece
Spatial information of 0.2 Airy units for each SPPC

Capture wide views at high speeds

Featuring a field-of-view with a diagonal of 22 mm for both resonant and Galvano scanners, the AX R MP captures more data per single frame at any magnification. This is incredibly beneficial for faster acquisition of large specimens, or a wider perspective for time-lapse imaging.

High magnification acquisition over a wide area

The larger FOV of the AX R MP can benefit imaging in several ways:

- More of the sample is visible in each frame and more data can be collected, without changing objectives
 - More details are visible while keeping the same FOV when using higher resolution/magnification lenses
- Ultimately this means that you can save time, especially when producing higher quality stitched images.

High-speed scanning that reliably captures dynamic events

The resonant scanner of the AX R MP provides high-speed imaging while maintaining a large field of view of 22 mm. Total acquisition time is exponentially reduced compared to Galvano-based imaging. This also means a shorter illumination time and less phototoxicity in the sample. By setting an ROI, ultra-fast imaging of up to 720 fps (2048 x 16 pixels) can be achieved.

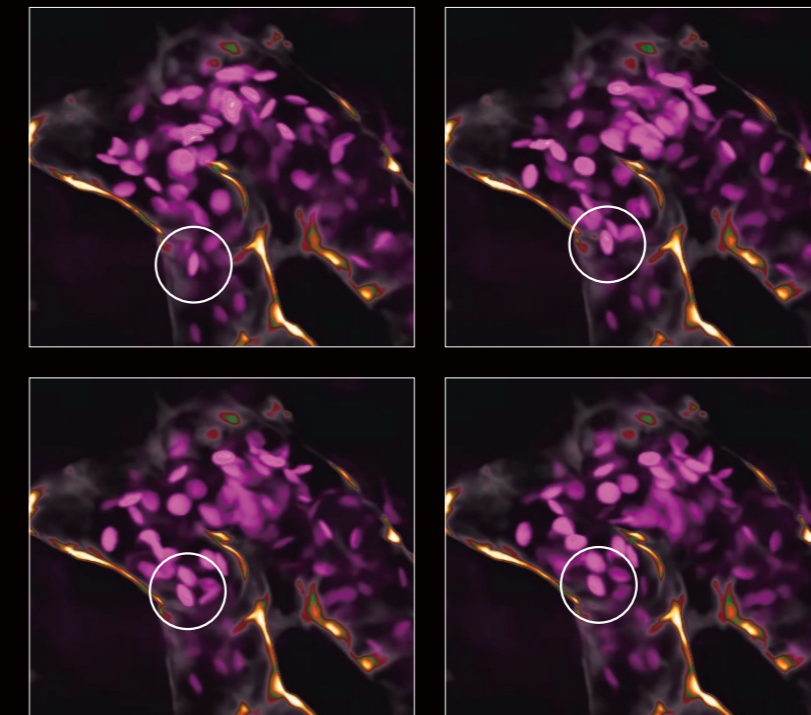

Sample video

Embryonic zebrafish, Blood vessels: GFP, Blood cells: RFP
Individual blood cells are identified in high resolution, and blood flow is imaged at a high speed of 28 fps (2048 x 546 pixels)
Images courtesy of Erika Dreikorn and Dr. Beth Roman, Department of Human Genetics, University of Pittsburgh Graduate School of Public Health
Objective: CFI75 Apochromat LWD 20XC W

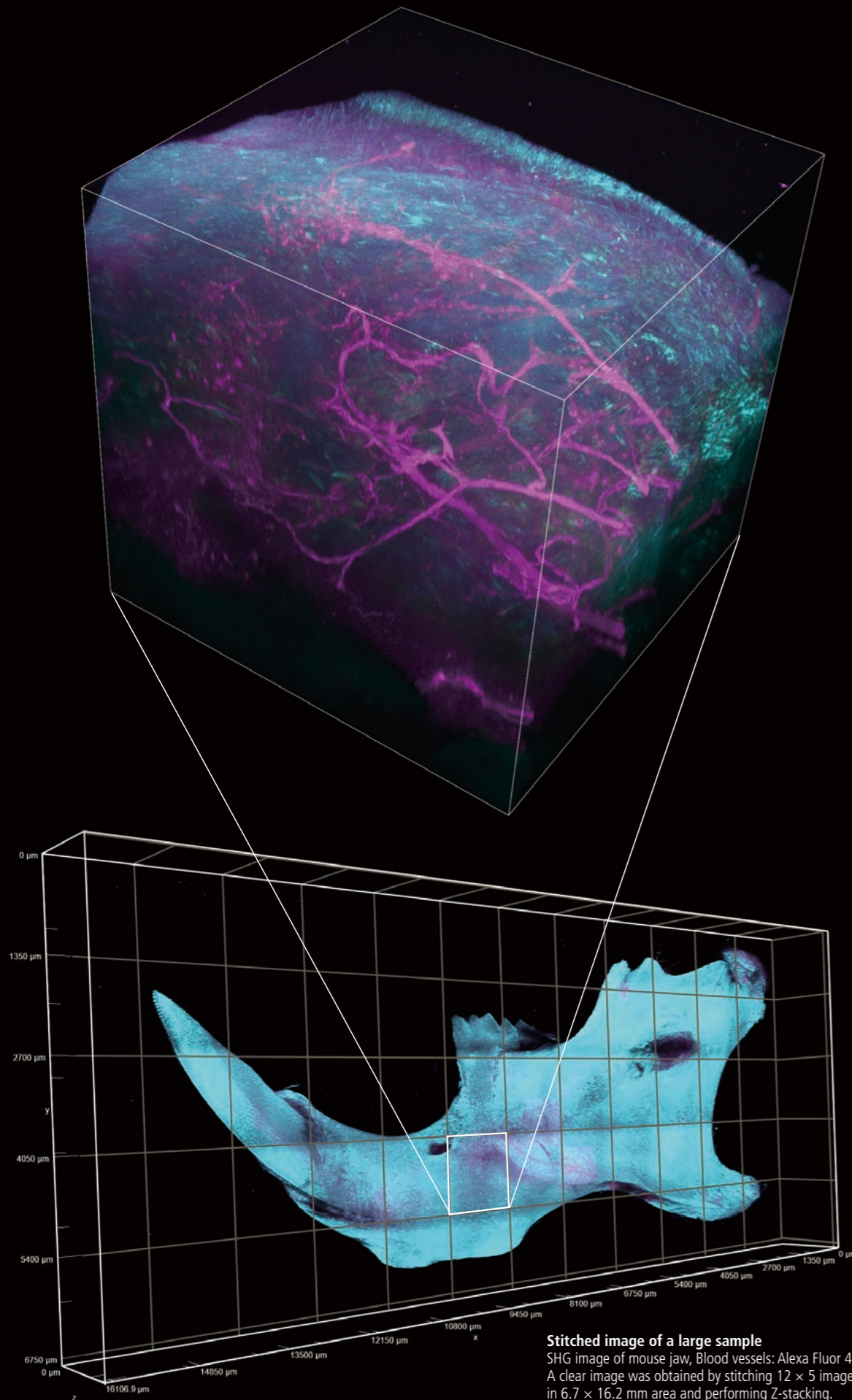

Stitched image of a large sample

SHG image of mouse jaw, Blood vessels: Alexa Fluor 488
A clear image was obtained by stitching 12 x 5 images acquired in 6.7 x 16.2 mm area and performing Z-stacking.
Image courtesy of Lin Daniel, PhD, SunJin Lab Co.
Objective: CFI Plan Apochromat Lambda D 10X

Bright, high-definition imaging of deep structures

Multiphoton resonant imaging of up to 2K x 2K provides high resolution images even to deep areas within specimens. Fluorescence from deep areas can be reliably captured by suppressing signal loss with a high-sensitivity detector.

High resolution deep imaging for intravital microscopy

The AX R MP's two selectable scanners, resonant and Galvano, allow users flexibility in acquisition, and provide both high-speed and high-resolution solutions. The Galvano scanner is capable of obtaining 8192 x 8192 pixel high resolution images, with a pixel density that enables Nyquist sampling at any magnification. The high-speed resonant scanner supports high resolution imaging with pixel densities of up to 2048 x 2048. Both can visualize morphological changes in deeper regions in fine detail.

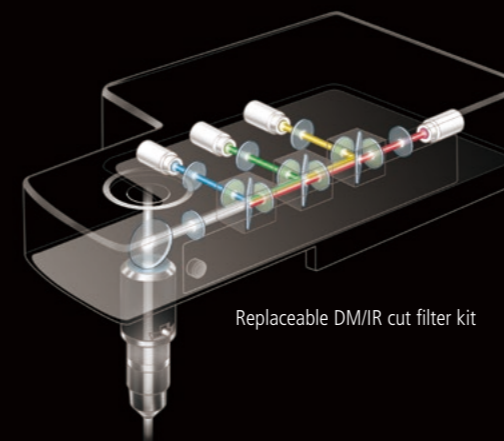
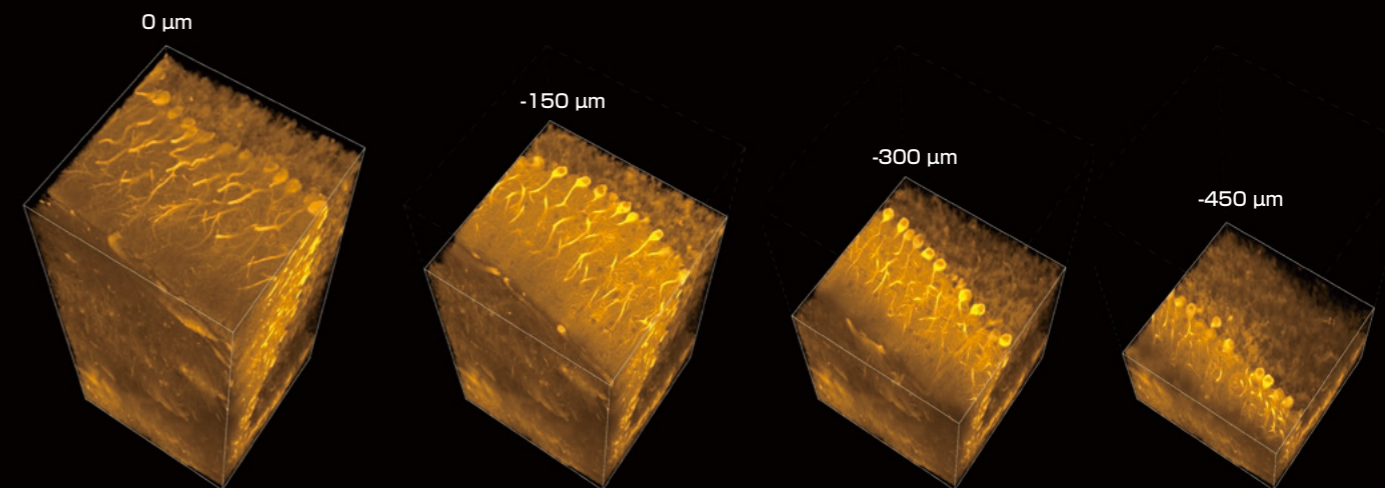
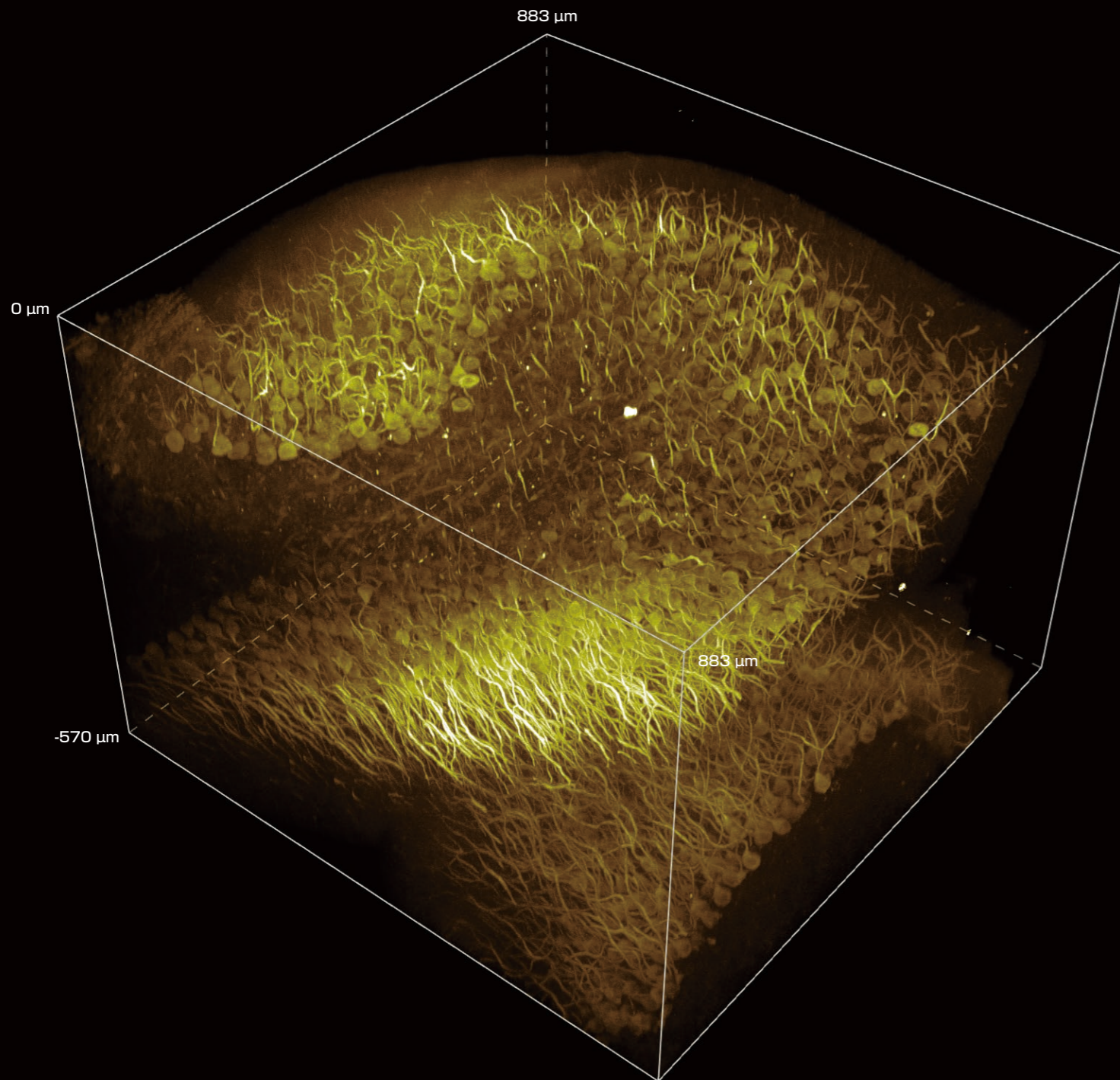

High-sensitivity detection of signals from deep areas

The AX R MP's non-descanned detectors (NDDs) are placed in flexible configurations near the back aperture of the objective for maximum emission collection. Flexible configurations from 2 to 4 channels in multi-alkali PMT or GaAsP PMT, depending on target emission wavelengths, are also standard options.

MIP image of mouse brain, Prukinje: GFP
Z-stack imaging at an excitation wavelength of 920 nm using a 2K resonant scanner. Individual nerve cells in the depths are visualized with high S/N ratio.
Images courtesy of Dr. Laurence Dubreil, Dr. Julien Pichon and Pr Marie-Anne Colle, PAnTher UMR703 INRAE/Oniris, Nantes France
Objective: CF175 Apochromat LWD 20XC W



Sample video

NSPARC detector

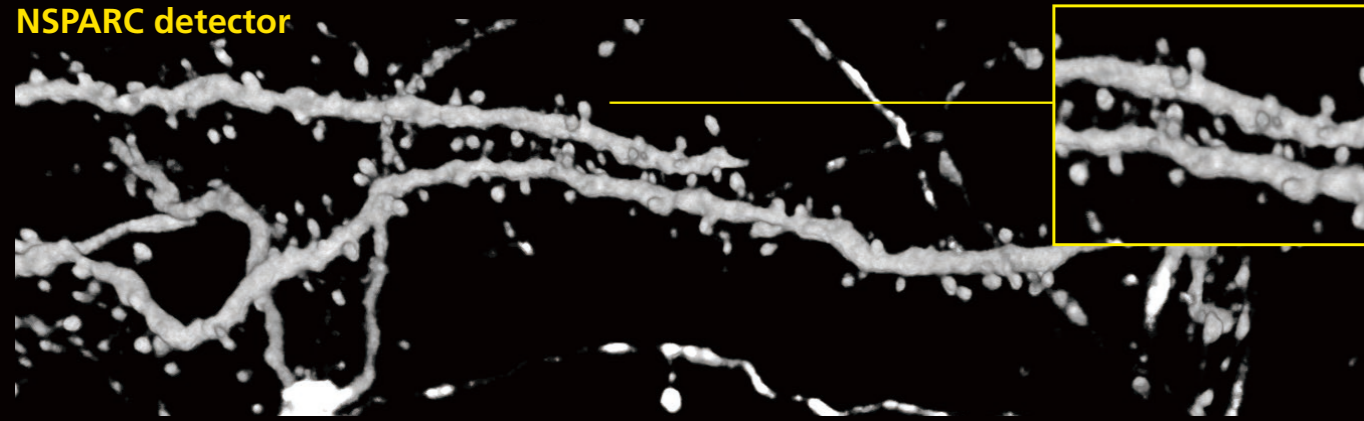

NDD

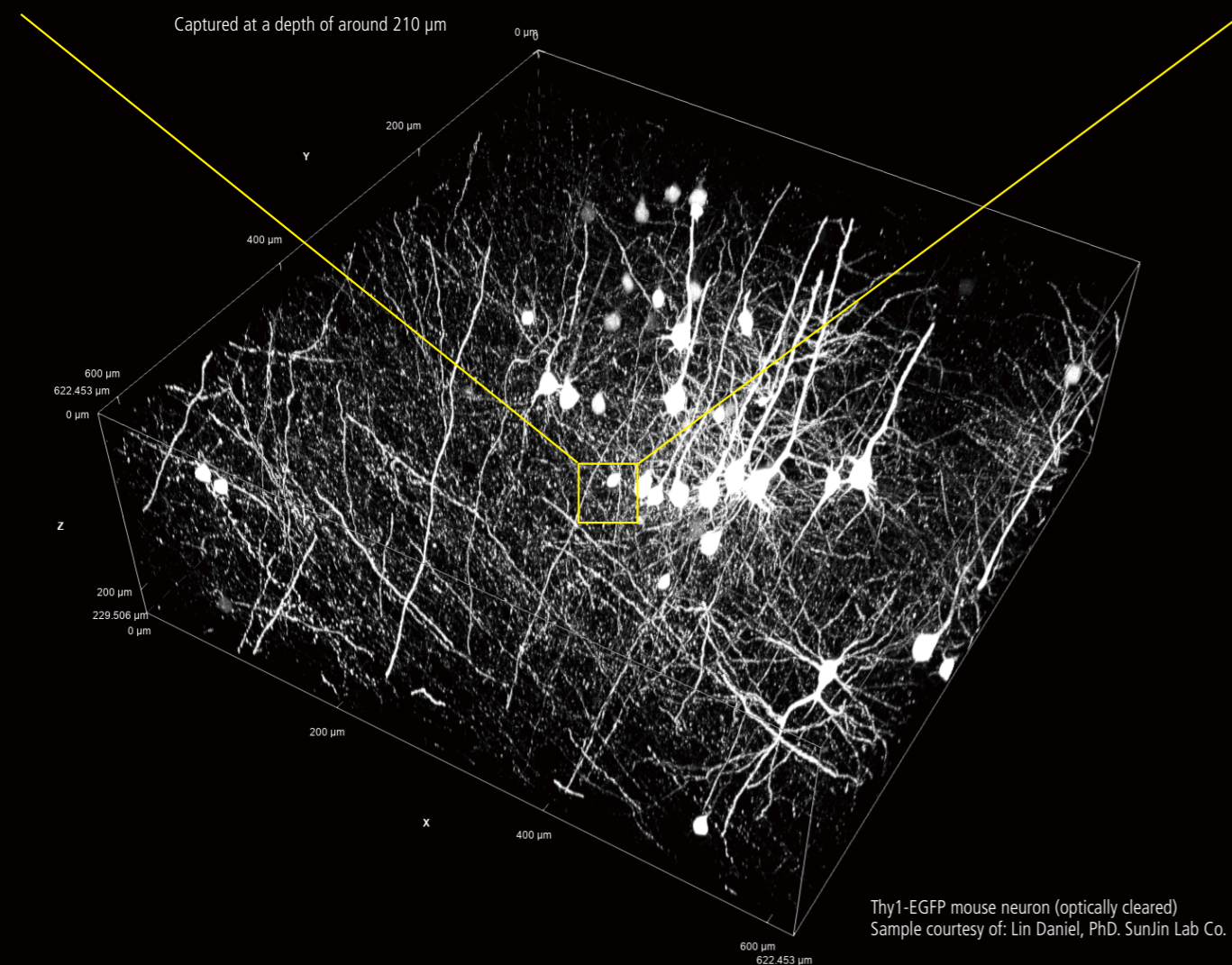
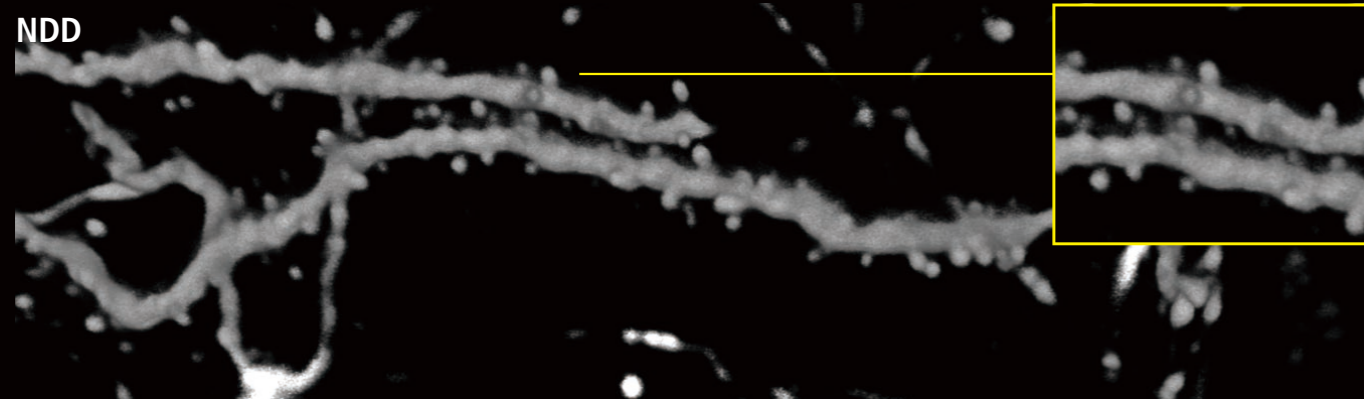

Realizes deep imaging with super resolution

The newly developed NSPARC (Nikon SPatial ARray Confocal) super-resolution detector collects two-dimensional information for each pixel by utilizing an array detector. NSPARC technology enables high-resolution image acquisition with increased signal-to-noise ratio (S/N), providing more spatial information than NDDs. Super-resolution images and excellent S/N can be achieved even in deep areas, enabling fine detailed structures to be acquired there. NSPARC's sensitive detection will benefit a wide range of sampling, contributing to more accurate studies.

NSPARC spatial array detector technology

The NSPARC detector comprises an array detector with 25 Single Pixel Photon Counters (SPPCs) that enables collection of two-dimensional spatial information at each scanned pixel, rather than collecting only one intensity value per pixel. By controlling zoom optics, the size of the illumination spot projected onto the detector array can be adjusted to 1 airy unit, and 0.2 airy units worth of information can be acquired with each SPPC. This allows the NSPARC detector to reconstruct images with higher spatial resolution than traditional NDDs.

With NSPARC detection, the fluorescence emission light is directed through optical lenses to the detector array, where the projected light can fill the array.

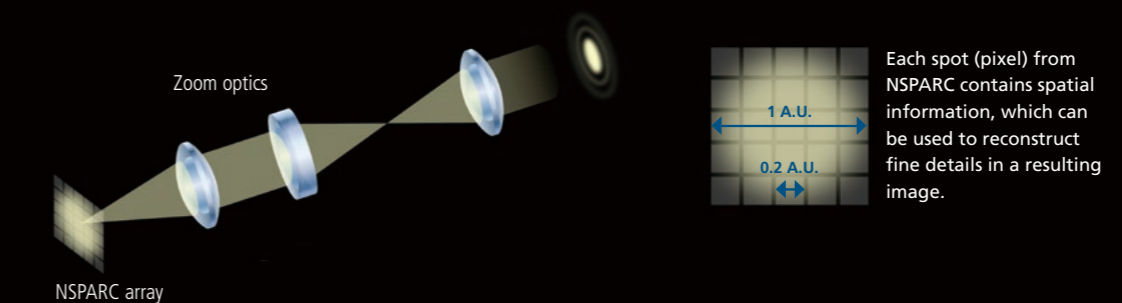

Accommodates macro to micro imaging of large samples

With its large FOV and expansive space under the objective, the AX R MP enables image acquisition of varied specimens and sample sizes. Combined with the NSPARC detector, the AX R MP allows imaging from macro to micro. Imaging of both large samples using traditional detection and super-resolution imaging of fine structures can be achieved within a single experiment. It can also be used while switching to and from confocal detectors, depending on the condition of the sample.

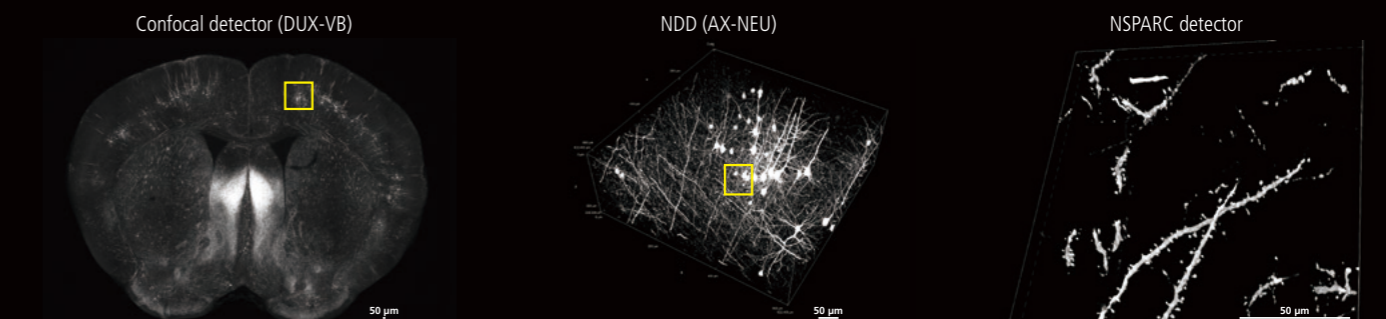

The AX R MP with NSPARC supports the entire range of imaging applications, from macro imaging of a sample by image stitching to micro imaging using the super-resolution detector.

Large space for a wide range of sample setups

The motorized upright microscope dedicated for AX R MP provides a clearance of 40 cm under the objective. Two types of motorized stand are available, both providing a large amount of free space around the sample without the need for customization, and improves sample positioning flexibility and accessibility to samples. Also, the angle of the objective is adjustable, providing even more flexibility and enabling the sample to be observed in its natural posture.

Gate stand

For systems requiring depth



Single stand

For systems requiring breadth



Ample space around the sample

The stage is separated from the microscope to ensure a large space under the objective. Two types of stand are available for different observation purposes. The gate stand has a large space extending in the longitudinal direction, and the single stand has a large space extending in the lateral direction.

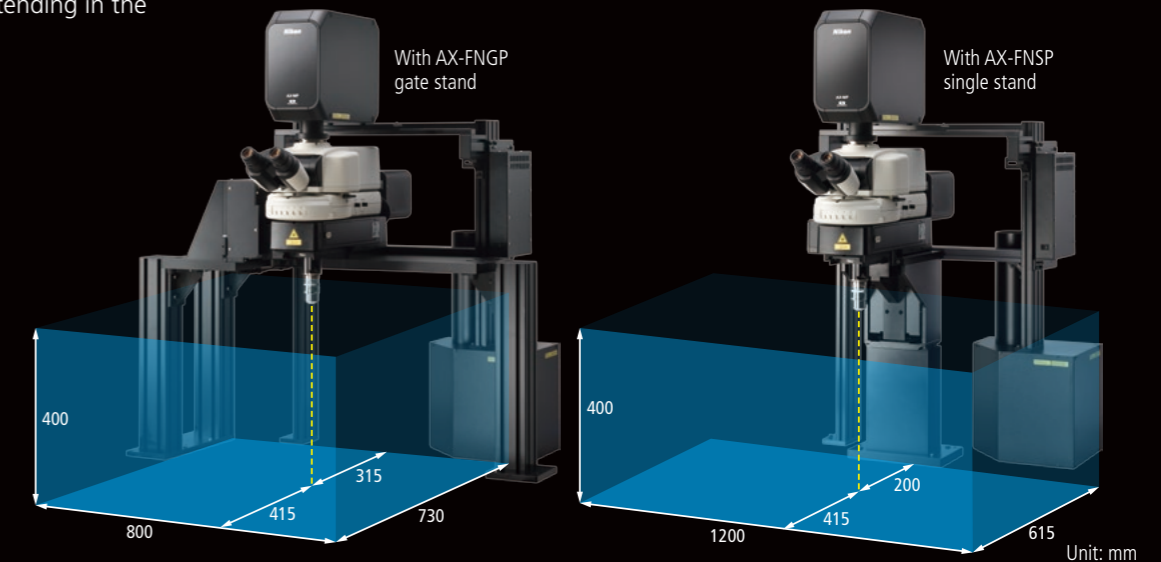

Observe samples in their natural postures

Nikon has developed the new CF175 single tilting nosepiece that can adjust the objective to different angles. It enables observation of a sample in the lateral and oblique directions without changing its orientation, reducing the load on the sample. The Piezo Z device (optional) allows for highly accurate, high-speed Z imaging.

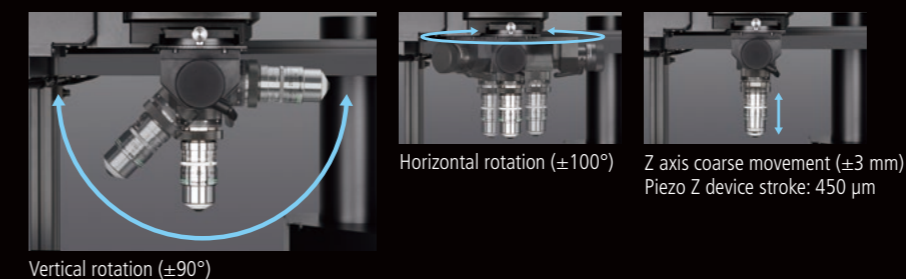

Highly accurate sample positioning

The dedicated motorized stage enables highly precise movement of samples such as tissue sections and culture dishes, within the range of ± 34 mm (X) and ± 27 mm (Y), using a joystick.



The AX R MP can also be mounted on the TI2 inverted microscope.

Software for deep, wide imaging

NIS-Elements C control software enables centralization of workflow from image acquisition to analysis, making it easy to customize experiment templates that combine multiple settings.

AI software innovations designed to assist

The optional software module NIS.ai is equipped with image processing tools and customization functions. Utilizing deep learning and AI technology, it automates image acquisition and generation of optimal images for analysis.

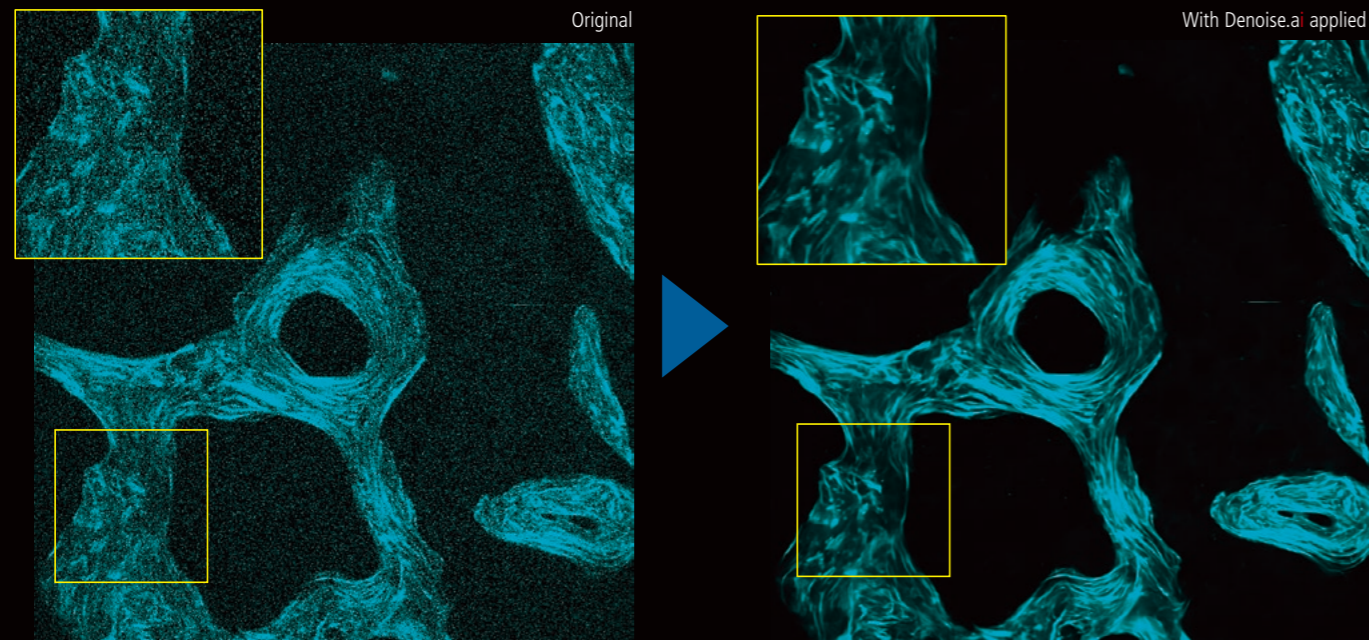

SHG images of un-decalcified bone section of a monkey captured at 920 nm IR excitation wavelength
Image courtesy of Dr. Tadahiyo Jimura and Dr. Takanori Sato of the Department of Pharmacology, Faculty and Graduate School of Dental Medicine, Hokkaido University

Denoise.ai, a standard module in the NIS-Elements C and C-ER imaging software, automatically removes Poisson shot noise from resonant confocal images. Resonant scanning results in ultrashort (tens of nanoseconds) dwell times that are extremely favorable for reducing phototoxicity and increasing specimen viability for long term imaging. While resonant scanning at very short exposure times usually requires line averaging to reduce Poisson shot noise contributions, users instead can employ Denoise.ai to eliminate the noise component. Denoise.ai can recognize and remove the shot noise components of images, increasing clarity and allowing for shorter exposure times and longer time-lapse experiments, while maintaining viability.



Application note

High-resolution image capture with a single click

NIS-Elements C-ER assesses captured images and automatically determines processing parameters to achieve enhanced resolution. Higher resolution confocal images (up to 120 nm resolution in XY and 300 nm in Z)* can be easily generated with a single click. * For confocal imaging.

Unmix wavelength crosstalk

Multiphoton excitation makes simultaneous excitation of multiple fluorescent probes with a single IR wavelength possible. When there is significant crosstalk in images acquired via multiple channels, fluorescent separation (spectral unmixing) allows clear separation of dyes.

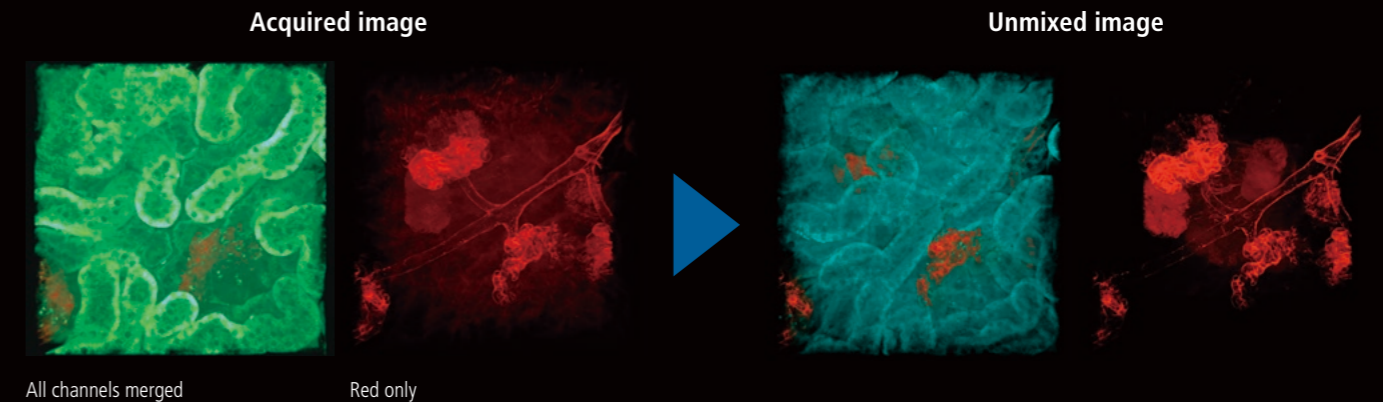

Multicolor fluorescent images of mouse kidney
Red: blood vessels (Alexa Fluor 594), Cyan: SHG, Green: Autofluorescence

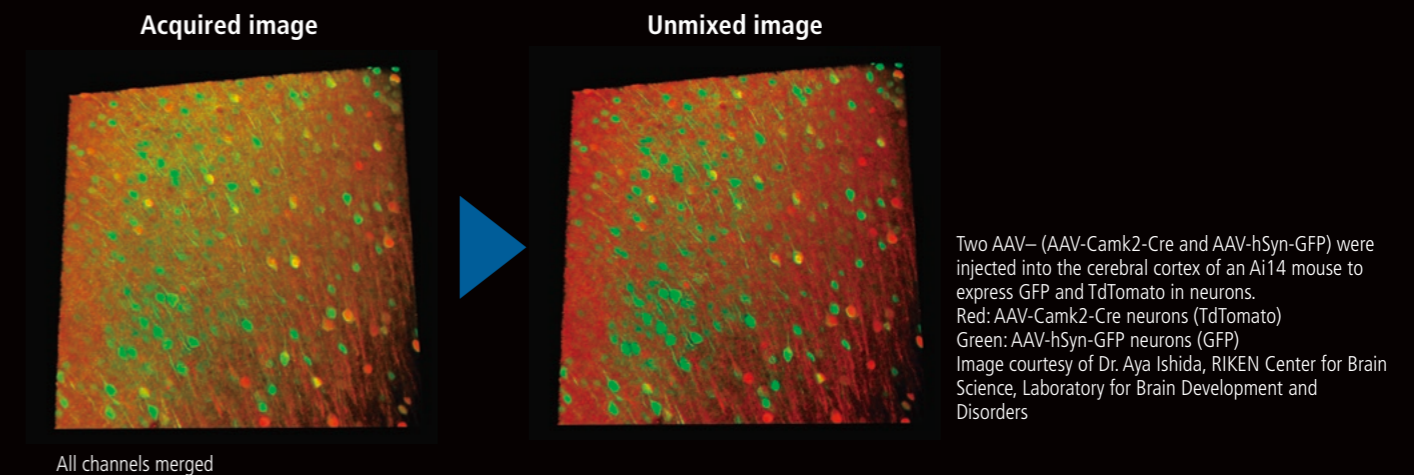

Two AAV- (AAV-Camk2-Cre and AAV-hSyn-GFP) were injected into the cerebral cortex of an Ai14 mouse to express GFP and TdTomato in neurons.
Red: AAV-Camk2-Cre neurons (TdTomato)
Green: AAV-hSyn-GFP neurons (GFP)
Image courtesy of Dr. Aya Ishida, RIKEN Center for Brain Science, Laboratory for Brain Development and Disorders

Deconvolution improves image quality in deep areas

Deconvolution processing is effective in capturing detailed structures in deep areas because it reduces image elongation in the optical axis direction.

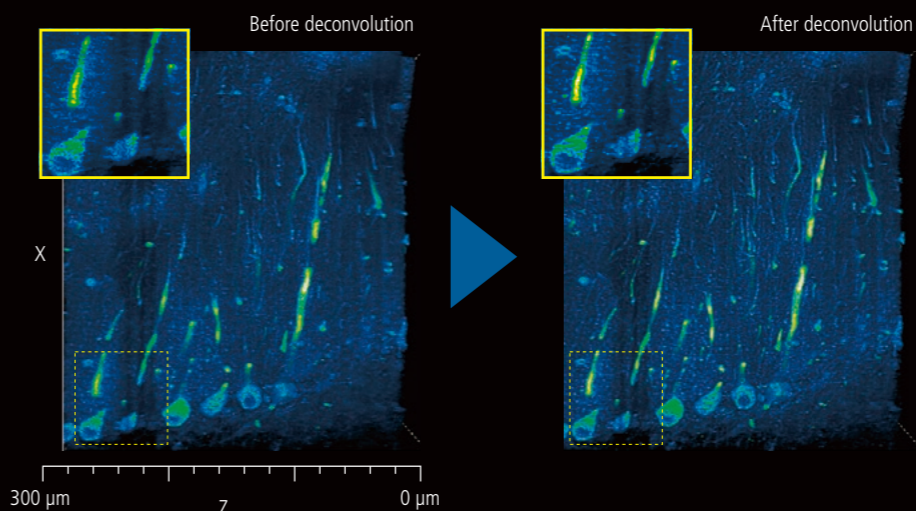

Slices of the cerebellum of a LC3GFP mouse.
The right side of each image is the surface layer and left side is at a depth of about 300 μm.
Blue: cerebellum (autofluorescence)
Green: Purkinje cells
Image courtesy of Dr. Laurence Dubreil, Dr. Julien Pichon and Pr. Marie-Anne Colle, PAnTher UMR703 INRAE/Oniris, Nantes France

Bright images, high quality

A wide range of high NA objectives that correct chromatic aberrations up to the near infrared wavelength range and support multiphoton excitation imaging is provided.



CFI75 Apochromat LWD 20XC W

Supports large field of view observation with an FOV of 22 mm. This objective makes it possible to observe deep inside the sample, with a long working distance of 2.8 mm. This low-magnification water-immersion objective is bright up to the periphery of its wide field of view.

CFI90 20XC Glyc

This objective is capable of correcting the refractive index of the immersion liquid from 1.44 to 1.50. It has a large field of view, high NA (1.00), and long working distance (8.20 mm). It also corrects chromatic aberration up to 1300 nm.



CFI Apochromat Lambda S 40XC WI

This objective has the highest NA (1.25) among water immersion objectives. It is bright and has high resolution, and is suitable for confocal live cell imaging.



CFI Plan Apochromat 10XC Glyc

Since this objective is able to correct the refractive index of the immersion liquid from 1.33 to 1.51, it supports various tissue-clearing technologies. It makes 3D observation of deeper areas in living tissue possible.



CFI75 Apochromat 20XC W 1300

This objective has a long working distance (2.0 mm) and high NA (1.10), and corrects chromatic aberration up to 1300 nm. Since it can also correct spherical aberration due to depth, it is suitable for deep multiphoton imaging.



CFI Apochromat LWD Lambda S 20XC WI

This is a high-performance, highly versatile objective that boasts a high NA (0.95), a large view field, and a long working distance (0.95 mm).



Nano Crystal Coat for superior transmissivity

Nikon's exclusive Nano Crystal Coat is an anti-reflective coating consisting of ultrafine crystalline particles. This forms a coarse structure that enables lower refractive indices, facilitating the passage of light through the lens rather than reflecting it, thus providing superior light transmission.

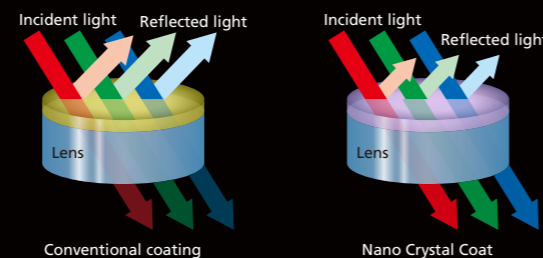

Support for visible light imaging

The AX R MP supports observation not only at infrared wavelengths, but also at visible wavelengths. It enables both multiphoton imaging and confocal imaging with a single microscope. It also enables simultaneous photostimulation and imaging using two different wavelengths.

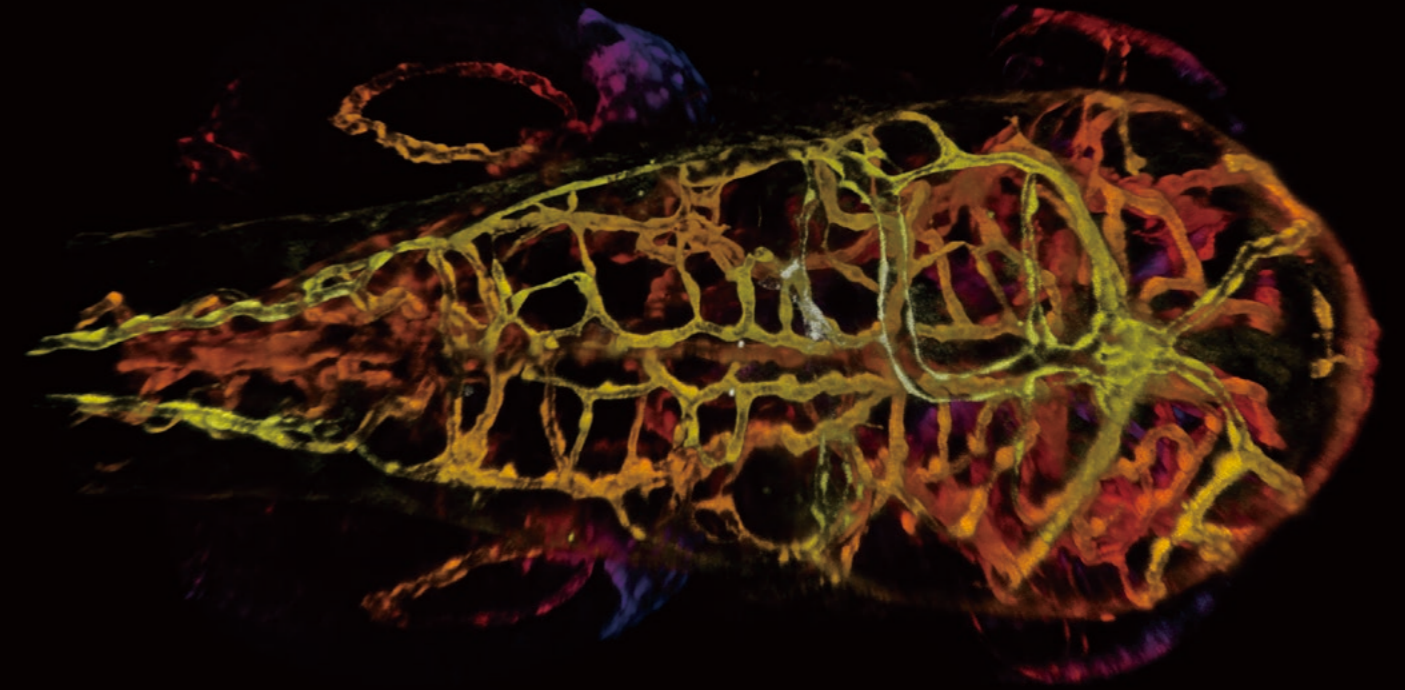

Opti-Microscan photostimulator (optional)

Photostimulation using wavelengths* of 405 nm, 488 nm, and 561 nm enables simultaneous visible light stimulation and IR imaging. Stimulation modes include simultaneous, sequential, and manual stimulation.

*Limited by the specifications of the filter cube used.



DUX-VB high-sensitivity visible light detector unit

The transmission wavelength band of the LVF (Linear Variable Filter) employed in the DUX-VB gradually changes depending on its location, enabling continuous tuning of the wavelength detection setting within a range of 400 nm to 750 nm.

From 2 to 4 channels can be selected, and high sensitivity GaAsP PMT can be used for all channels.

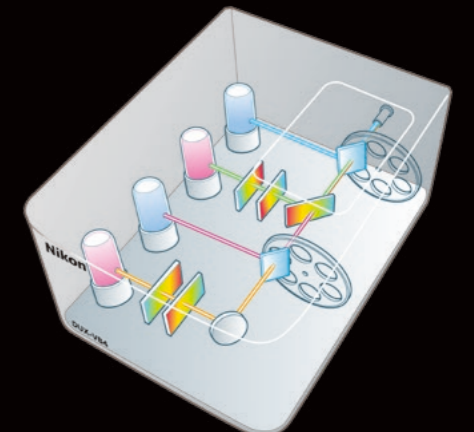

System diagram (AX R MP)

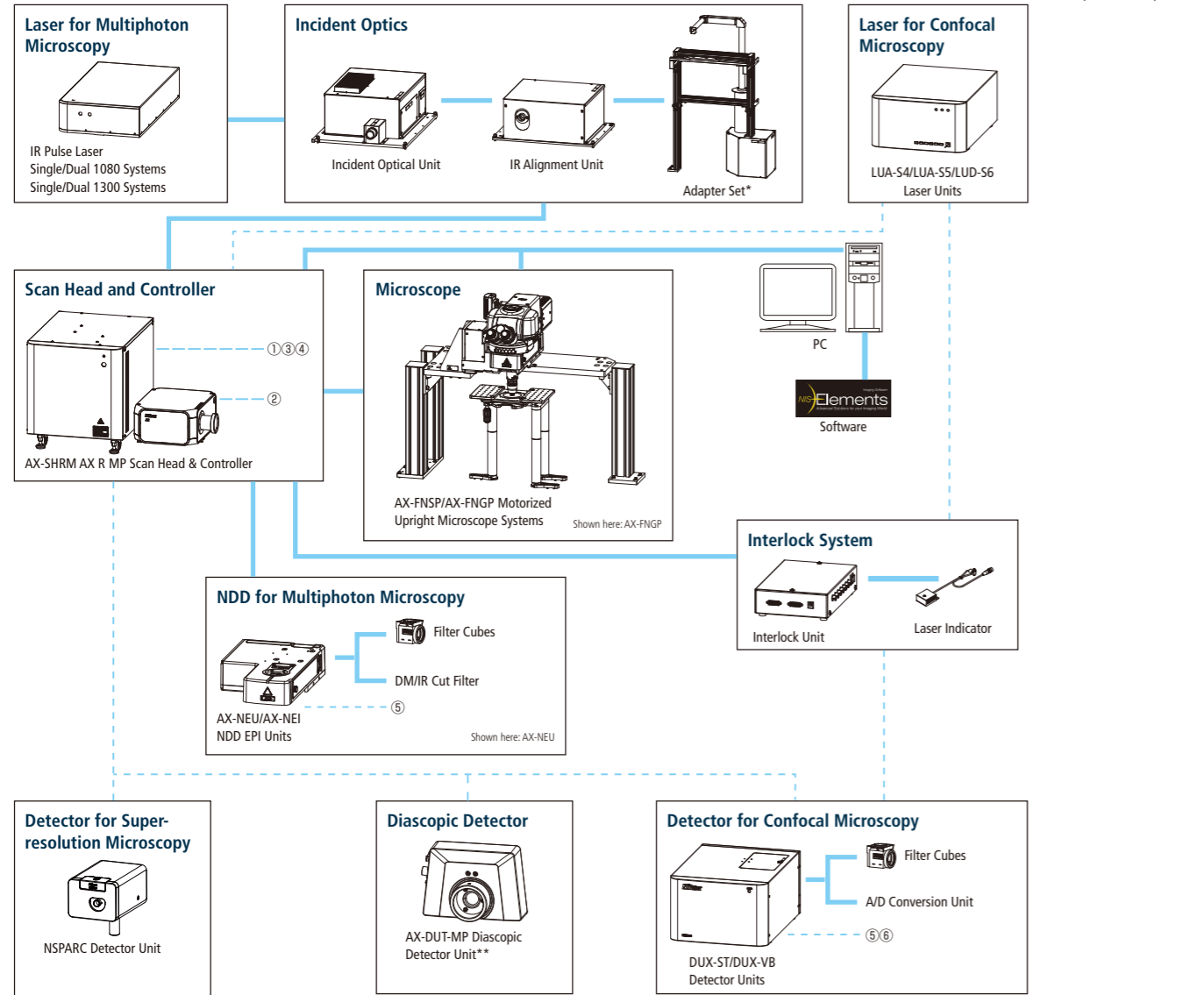

Options

- ① AX external trigger cable
- ② AX 1st dichroic mirror/AX emission port option
- ③ MP diascopic detector unit/NDD EPI protective shutter/Piezo devices
- ④ AD-R1K-MP/AD-R2K-MP A/D conversion units
- ⑤ PMT-GA-MP/PMT-MA-MP PMT Units
- ⑥ Additional channel unit for DUVB

* Only for use with AX-FNSP/AX-FNGP.
** Cannot be used with AX-FNGP.

Layout

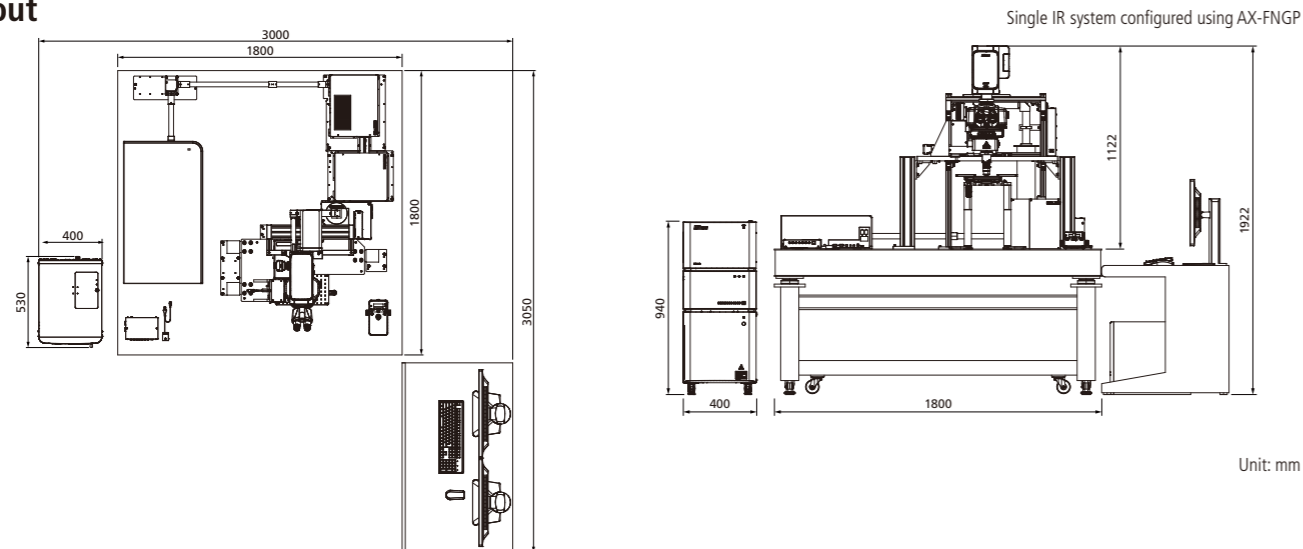

Specifications (dedicated AX-FN motorized upright microscope)

		AX-FNSP	AX-FNGP
Main body	Optical system	Infinity optical system	
	Microscope stands	AX-FNSP Single Stand	AX-FNGP Gate Stand
	Focusing	<ul style="list-style-type: none"> AX-FN Focusing Nosepiece Unit Motorized coaxial coarse/fine focusing Focusing stroke: Up 13 mm/Down 2 mm^{*1, *2}, Minimum step: 0.02 μm, Motorized escape and refocus mechanism Focal plane: 400 mm above the surface of the vibration isolated table 	
Controls	Controls	<ul style="list-style-type: none"> AX-FNCTL Control Box AX-FNHC Hub Controller (For controlling Focusing Nosepiece Unit, Diascopic Illumination System, Stage Joystick, Motorized Epi-fluorescence Cube Turret, Motorized Quadrocular Tilting Tube 2 and DSC Zooming Port) 	
	PC	<ul style="list-style-type: none"> Elements Software 	
Tubes		Pupillary distance: 50-75 mm, Inclination angle: 15-35 degrees, Eyepiece/Upper port/Rear port: 100/0/0, 0/100/0, 0/0/100 via DSC Zooming Port <ul style="list-style-type: none"> NI-TT2 Quadrocular Tilting Tube 2, With interlock function NI-TT2-E Motorized Quadrocular Tilting Tube 2, With interlock function 	
Eyepieces (F.O.V. (mm))		<ul style="list-style-type: none"> CFI 10X (22) CFI 12.5X (16) CFI 15X (14.5) CFI UW 10X (25) 	
Photodetector		<ul style="list-style-type: none"> AX-NEU Non-descanned EPI Upright Detector 	
Nosepieces		<ul style="list-style-type: none"> FN-S2N CFI60 Sliding Nosepiece, Forward-backward sliding type, two positions, DIC prism slider can be attached FN-S2N-2 CFI90 2 Place Sliding Nosepiece^{*5}, Forward-backward sliding type, two positions, DIC prism slider can be attached to the front objective FN-MN-H CFI75 Holder^{*5}, one position, DIC prism slider can be attached FN-MN-H2 CFI90 Holder^{*3}, one position AX-FNTN-H CFI75 Single Tilting Nosepiece^{*3, *4, *5}, one position 	
Stages	Adapter	<ul style="list-style-type: none"> AX-FNSA Stage Adapter, supporting both manual and motorized XY stages. Stage height: adjustable to 2 positions depending on sample size (400 mm/200 mm from the surface of the vibration isolated table) 	
	Stage	<ul style="list-style-type: none"> FN-3PS2 XY stage, Cross travel 29.5 (X) x 29.5 (Y) mm, with 2 auxiliary plates AX-FNS-E Motorized XY stage, Cross travel ±34 (X) x ±27 (Y) mm 	
Epi-fluorescent illuminator	Illumination unit	<ul style="list-style-type: none"> NI-FLEI-2 Epi-fluorescence attachment 	
	Light source	<ul style="list-style-type: none"> D-LEDI Fluorescent LED Illumination System 	
	Filter cube turret	6 mountable filter cubes, shutter function <ul style="list-style-type: none"> NI-FLT6 Epi-fluorescence Cube Turret NI-FLT6-I Intelligent Epi-fluorescence Cube Turret NI-FLT6-E Motorized Epi-fluorescence Cube Turret 	
	Photostimulation device	<ul style="list-style-type: none"> AX-FNBPU Stimulation Back Port, 6 mountable filter cubes, Fluorescence imaging and simultaneous stimulation imaging can be switched 	
Diascopic illuminator	Illumination unit	<ul style="list-style-type: none"> AX-FNDIA Diascopic Unit 4 filter slider attachable, Condenser holder stroke: Up 2.5 mm/Down 1.8 mm, NI-PT Polarizer Turret mountable 	
	Light source	<ul style="list-style-type: none"> Halogen Lamp (12V100W) NI-LH Precentered Lamphouse FN-LH Precentered Lamphouse High Luminescence White LED Illuminator LV-LL LED Light Source 	
	Shutter	<ul style="list-style-type: none"> NI-SH-E Motorized Shutter 	
	Condenser	<ul style="list-style-type: none"> FN-C LWD condenser, O.D. 8.2 mm, NA: 0.78 	
	Polarizer Turret	<ul style="list-style-type: none"> NI-PT Polarizer Turret, Visible or infrared polarizer attachable 	
Observation methods		Brightfield, Epi-fluorescence, DIC, IR-DIC	
Power consumption		100W	
Weight (approx.)		66 kg (fully motorized fluorescence system, with diascopic illuminator)	66 kg (fully motorized fluorescence system)

- *1 Based on the focus position
- *2 Software controlled value
- *3 DIC prism slider cannot be attached
- *4 FOV 12, Usable objectives: CFI75 LWD 16X W, CFI75 Apochromat LWD 20XC W, CFI75 Apochromat 25XC W, CFI75 Apochromat 25XC W 1300
- *5 Cannot be used with diascopic illumination. The FN-MN-H cannot be used with diascopic illumination only when the 400 μm objective piezo positioner (PI) is attached.

Specifications (AX R MP)

		AX R MP	
Scan head	Type	AX-SHRM AX R MP Scan Head & Controller	
	FOV	ø22 mm	
	Standard image acquisition		Galvano scanner
			Pixel size: max. 8192 x 8192 pixels
			Scanning speed: max. 240 fps (512 x 16 pixels), 10 fps (512 x 512 pixels)
	High-speed image acquisition		Resonant scanner
			Pixel size: max. 2048 x 2048 pixels
			Scanning speed: max. 720 fps (2048 x 16 pixels for 2K, 1024 x 16 pixels for 1K), 30 fps (2048 x 512 pixels for 2K, 1024 x 512 pixels for 1K)
	Scan mode	Line scanning, bi-direction scanning and averaging	
	Simultaneous acquisition	Max. 5 channels (including a diascope detector channel)	
	IR laser wavelength range	700-1080 nm (1080 system), 820-1300 nm (1300 system)	
	Dichroic mirror	Position: 6	
Pinhole	6-153 µm variable		
Zoom	1-1000X continuously variable		
Input/output port	2 laser input ports 2 signal output ports		
Laser for multiphoton microscopy	Single 1080 system	Mai Tai HP/eHP DeepSee, Chameleon Vision II, Axon 920	
	Dual 1080 system	Chameleon Vision II + Axon 920, Axon 920 + Axon 1064	
	Single 1300 system	InSight X3, Chameleon Discovery NX	
	Dual 1300 system	InSight X3 Dual Option, Chameleon Discovery NX, Chameleon Discovery NX + Axon 920	
	Incident optics	700-1080 nm (1080 system), 820-1300 nm (1300 system), auto alignment	
	Modulation	Method: AOM (Acousto-Optic Modulator) device Control: power control, ROI exposure control	
Laser for confocal microscopy (option)	4-laser unit	405 nm, 488 nm, 561 nm and 640 nm lasers are installed	
	5-laser unit	405 nm, 488 nm, 561 nm, 594 nm and 640 nm lasers are installed	
	6-laser unit	405 nm, 445 nm, 488 nm, 515 nm, 561 nm and 640 nm lasers are installed	
NDD for multiphoton microscopy	NDD EPI unit AX-NEI (for Ti2-E) and AX-NEU (for AX-FNSP/FNGP)	Detectable wavelength range: 400-650 nm (1080 system), 400-750 nm (1300 system) Detectors: 2 GaAsP PMTs (4 GaAsP PMTs, or 3 GaAsP PMTs + 1 multi-alkali PMT are possible by adding options)	

Visible stimulation/IR imaging (option)	Opti-Microscan Photostimulator	Stimulation wavelength: 405 nm, 488 nm, 561 nm; Excitation wavelength for imaging: 800-1080 nm (1080 system), 820-1080 nm (1300 system) Stimulation speed: Max. 1 ms (point stimulation), Max. 20 µs/pixel (ROI stimulation) Stimulation modes: simultaneous, sequential, manual Stimulation area: square inscribed within a 22 mm-diameter circle, stimulation ROI: arbitrary pattern, no number limit
Diascopic detector (option)	AX-DUT-MP*1 (for AX-FNSP/Ti2-E)	Detectable wavelength range: 400-920 nm Detector: Multi-alkali PMT
Detector for confocal/multiphoton microscopy (option)	DUX-VB detector unit	Detectable wavelength range: 400-650 nm (with IR laser), 400-750 nm (with visible laser); Detection width: 10 nm to 320 nm Maximum pixel size: 8192 x 8192 (with Galvano scanner) Wavelength resolution: 5 nm, wavelength range variable in 1 nm steps Compatible with Galvano and resonant scanners 2 or 4 channels (Multi-alkali PMT or GaAsP PMT options)
	DUX-ST detector unit*2	Detectable wavelength range: 400-650 nm (with IR laser), 400-750 nm (with visible laser); 2 or 4 channels (Multi-alkali PMT or GaAsP PMT options)
	NSPARC Detector Unit	Equipped with SPPC (Single Pixel Photon Counter) array detector Up to 7 barrier filters can be mounted (Mountable filter: QuadBand446/523/600/677, 452/45, 525/50, 593/46, 700/75) With galvano scanner: Can be used with X resolution of 64 to 8192 pixels, Y resolution of 2 to 8192 pixels With resonant scanner: Can be used with X resolution of 256, 512 and 1024 pixels, Y resolution of 128 to 1024 pixels*3
Compatible microscopes		Dedicated AX-FNSP/AX-FNGP motorized upright microscope system, ECLIPSE Ti2-E motorized inverted microscope
Z step		AX-FNSP/FNGP: 0.02 µm, Ti2-E: 0.02 µm
Option	Motorized XYZ	Motorized XY stage (for AX-FNSP/FNGP/Ti2-E), High-speed piezo Z stage (for Ti2-E), High-speed piezo objective-positioning system (for AX-FNSP/FNGP)
	Nosepiece for AX-FNSP/FNGP	AX-FNTN-H CFI75 single tilting nosepiece*4
Software	Acquisition/analysis	Imaging software (equipped with Denoise.ai noise reduction function): NIS-Elements C or NIS-Elements C-ER
	Display/image generation	2D analysis, 3D volume rendering/orthogonal, 4D analysis, spectral unmixing
	Image format	JP2, JPG, TIFF, BMP, GIF, PNG, ND2, JFF, JTF, AVI, ICS/IDS
	Application	FRAP, FLIP, FRET(option), photoactivation, 3D time-lapse imaging, multipoint time-lapse imaging, colocalization
Control computer	OS	Windows®10 Pro 64 bit, Microsoft Windows® 11 Pro
Recommended installation conditions		Temperature 20 - 25°C, ± 1°C, air conditioning at all hours Humidity 60% RH or less (no condensation)

*1 Cannot be mounted on AX-FNGP

*2 Must be used with a confocal laser.

*3 Resolution of 2048 pixels cannot be set.

*4 FOV12, Compatible objectives: CFI75 LWD 16X W, CFI75 Apochromat LWD 20XC W, CFI75 Apochromat 25XC W and CFI75 Apochromat 25XC W 1300

AX series

Organelle structure in cultured cells



Cultured cells



Cell sheet/Preparation



Microchannel chip

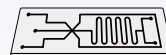

Sample animal



AX / AX R

AX NIR

AX R MP

AX / AX R with NSPARC

AX R MP with NSPARC

Specifications and equipment are subject to change without any notice or obligation on the part of the manufacturer. July 2023
©2022-23 NIKON CORPORATION



WARNING

TO ENSURE CORRECT USAGE, READ THE CORRESPONDING MANUALS CAREFULLY BEFORE USING YOUR EQUIPMENT.

Company names and product names appearing in this brochure are their registered trademarks or trademarks.
N.B. Export of the products* in this brochure is controlled under the Japanese Foreign Exchange and Foreign Trade Law. Appropriate export procedure shall be required in case of export from Japan.
*Products: Hardware and its technical information (including software)



NIKON CORPORATION

Shinagawa Intercity Tower C, 2-15-3, Konan, Minato-ku, Tokyo 108-6290, Japan
phone: +81-3-6433-3705 fax: +81-3-6433-3785
<https://www.healthcare.nikon.com/en/>



Nikon Instruments Inc.

1300 Walt Whitman Road, Melville, N.Y. 11747-3064, U.S.A.
phone: +1-631-547-8500; +1-800-52-NIKON (within the U.S.A. only)
fax: +1-631-547-0299
<https://www.microscope.healthcare.nikon.com/>

Nikon Europe B.V.

Stroombaan 14, 1181 VX Amstelveen, The Netherlands
phone: +31-20-7099-000
https://www.microscope.healthcare.nikon.com/en_EU/

Nikon Precision (Shanghai) Co., Ltd.

CHINA phone: +86-21-6841-2050 fax: +86-21-6841-2060
(Beijing branch) phone: +86-10-5831-2028 fax: +86-10-5831-2026
(Guangzhou branch) phone: +86-20-3882-0550 fax: +86-20-3882-0580
<https://www.nikon-precision.com.cn/>

Nikon Canada Inc.

CANADA phone: +1-905-625-9910 fax: +1-905-602-9953

Nikon France, Succursale de Nikon Europe B.V.

FRANCE phone: +33-1-4516-4516

Nikon Deutschland, Zweigniederlassung der Nikon Europe B.V.

GERMANY phone: +49-211-9414-888

Nikon Italy, Branch of Nikon Europe B.V.

ITALY phone: +39-055-300-9601

Nikon Europe B.V., Amstelveen, Zweigniederlassung Schweiz (Egg/ZH)

SWITZERLAND phone: +41-43-277-2867

Nikon UK, Branch of Nikon Europe B.V.

UNITED KINGDOM phone: +44-208-247-1717

Nikon Österreich, Zweigniederlassung der Nikon Europe B.V.

AUSTRIA phone: +43-1-972-6111

Nikon Singapore Pte. Ltd.

SINGAPORE phone: +65-6559-3651 fax: +65-6559-3668

Nikon Australia Pty Ltd

AUSTRALIA phone: +61-2-8767-6900

Nikon Instruments Korea Co., Ltd.

KOREA phone: +82-2-6288-1900 fax: +82-2-555-4415

NIKON INDIA PVT. LTD.

INDIA phone: +91-124-4688-500