



N-SIM E

Super Resolution Microscope



Shedding New Light On **MICROSCOPY**

Explore Nano world with Nikon

N-SIM E is a streamlined, affordable super-resolution system that provides double the resolution of conventional optical microscopes: the same level of superb resolution as Nikon Super Resolution Microscope N-SIM S.

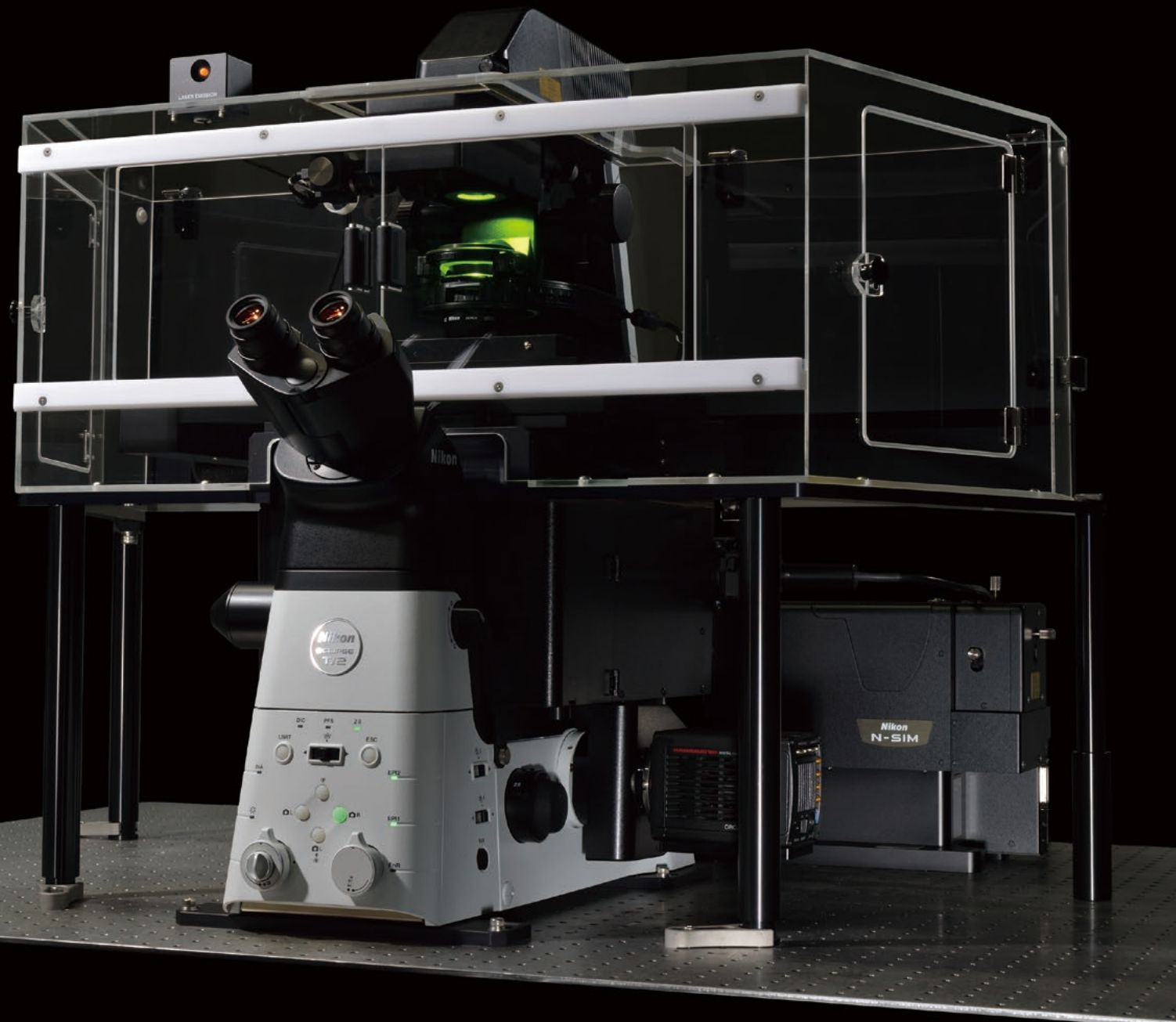

Simple imaging method switching

The N-SIM E can be simultaneously configured with a confocal microscope system, such as the AX, and imaging methods can be easily switched between super resolution imaging and confocal imaging. A desired location for the SIM image can be specified in a confocal image and acquired in super-resolution.

Confocal image

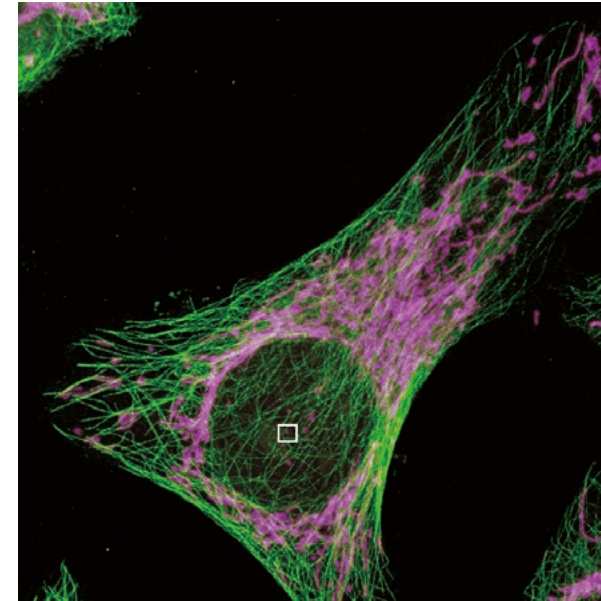

Select the location to acquire a SIM image in a confocal image

Super-resolution image

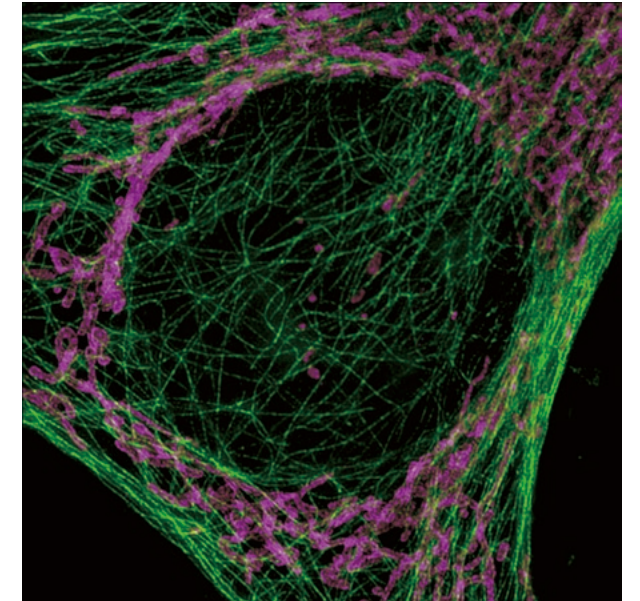

Acquire the SIM image of the selected location

Dry objective compatibility

Dry objectives are compatible with N-SIM E as well as confocal microscopes, so both confocal imaging and super resolution imaging are available without switching lenses.

Low-magnification and wide field-of-view dry lenses enable high resolution observation even at the periphery of sample tissue.



CFI Plan Apochromat Lambda 60XC
CFI Plan Apochromat Lambda 40XC

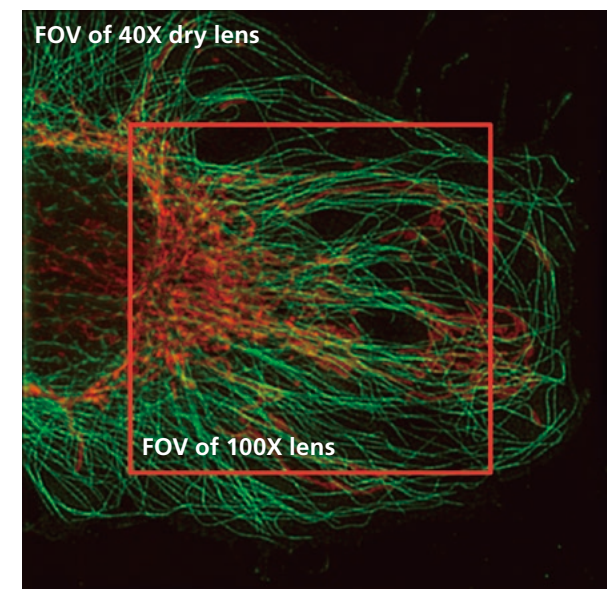

N-SIM E supports only essential, commonly used excitation wavelengths and imaging modes while providing the same super-resolution images as the N-SIM S, making it an obvious choice for individual labs.

Double the resolution of conventional optical microscopes

The N-SIM E utilizes Nikon's innovative new approach to "structured illumination microscopy" technology. By pairing this powerful technology with Nikon's renowned CFI SR HP Apochromat TIRF 100XC Oil objective (NA1.49), the N-SIM E nearly doubles the spatial resolution of conventional optical microscopes (to approximately 115 nm*), and enables detailed visualization of the minute intracellular structures and their interactive functions.

*Excited with 488 nm laser, in 3D-SIM mode

Super-resolution image (3D-SIM)

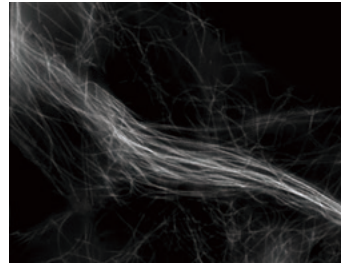

Conventional widefield image

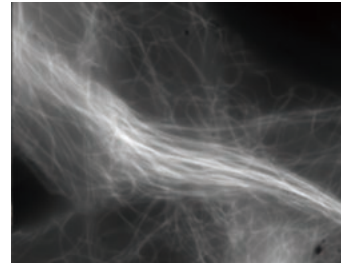

Microtubules in B16 melanoma cell labeled with YFP
Objective: CFI Apochromat TIRF 100XC Oil (NA 1.49)
Image capturing speed: approximately 1.8 sec/frame (movie)
Reconstruction method: Slice
Photographed with the cooperation of: Dr. Yasushi Okada, Laboratory for Cell Polarity Regulation, Quantitative Biology Center, RIKEN

Super-resolution image (3D-SIM)

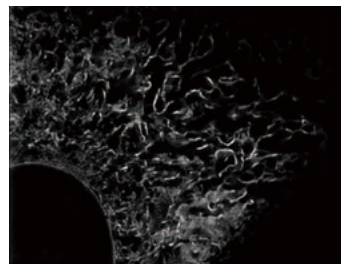

Conventional widefield image

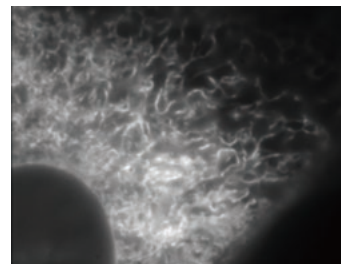

Endoplasmic reticulum (ER) in living HeLa cell labeled with GFP
Objective: CFI Apochromat TIRF 100XC Oil (NA 1.49)
Image capturing speed: approximately 1.5 sec/frame (movie)
Reconstruction method: Slice
Photographed with the cooperation of: Dr. Ikuo Wada, Institute of Biomedical Sciences, Fukushima Medical University School of Medicine

Axial super-high resolution imaging with 3D-SIM mode

Two reconstruction methods are available. Slice reconstruction allows axial super-resolution imaging with optical sectioning at 300 nm resolution in live-cell specimens. Optional stack reconstruction can image thicker specimens with higher contrast than slice reconstruction.

Super-resolution image (3D-SIM)

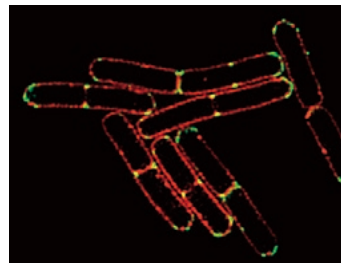

Conventional widefield image

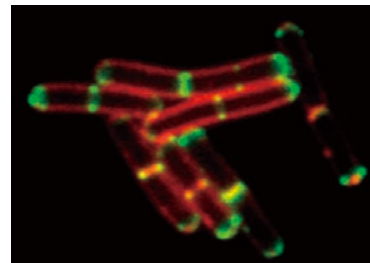

Bacillus subtilis bacterium stained with membrane dye Nile Red (red), and expressing the cell division protein DivIVA fused to GFP (green). The super-resolution microscope allows for accurate localization of the protein during division.
Reconstruction method: Slice
Photos courtesy of: Drs. Henrik Strahl and Leendert Hamoen, Centre for Bacterial Cell Biology, Newcastle University

3D-SIM (Volume view)

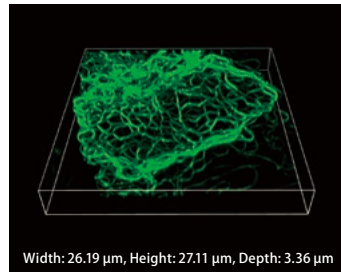

3D-SIM (Maximum projection)

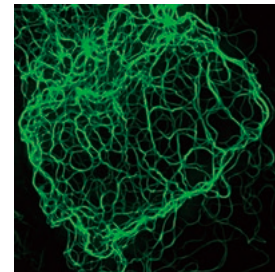

Mouse keratinocyte labeled with an antibody against keratin intermediate filaments and stained with an Alexa Fluor 488 conjugated second antibody.
Reconstruction method: Stack
Photos courtesy of: Dr. Reinhard Windoffer, RWTH Aachen University

Fast 1 sec/frame temporal resolution for super resolution imaging

N-SIM E provides fast imaging performance for Structured Illumination techniques, with a time resolution of approximately 1 sec/frame, which is effective for live-cell imaging.

The principle of the Structured Illumination Microscopy

Analytical processing of recorded moiré patterns, produced by overlaying a known high spatial frequency pattern, mathematically restores the sub-resolution structure of a specimen.

Utilization of high spatial frequency laser interference to illuminate sub-resolution structures within a specimen produces moiré fringes, which are captured. These moiré fringes include modulated information of the sub-resolution structure of the specimen. Through image processing, the unknown specimen information can be recovered to achieve resolution beyond the limit of conventional optical microscopes.

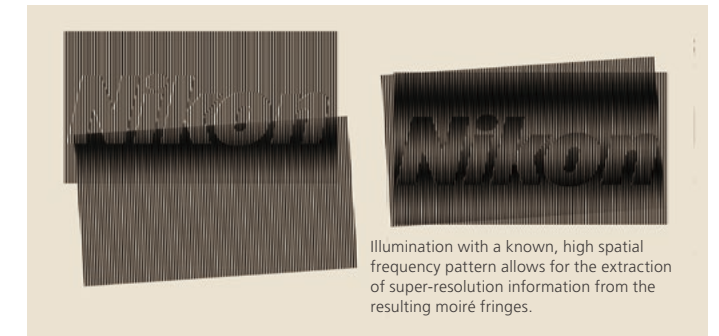

Create super-resolution images by processing multiple moiré pattern images

An image of moiré patterns captured in this process includes information of the minute structures within a specimen. Multiple phases and orientations of structured illumination are captured, and the displaced "super-resolution" information is extracted from moiré fringe information. This information is combined mathematically in "Fourier" or aperture space and then transformed back into image space, creating an image at double the conventional resolution limit.

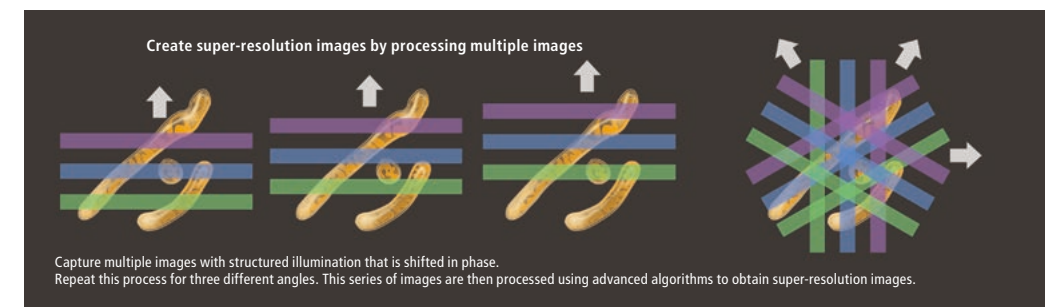

Utilizing high-frequency striped illumination to double the resolution

The capture of high resolution, high spatial frequency information is limited by the Numerical Aperture (NA) of the objectives, and spatial frequencies of structure beyond the optical system aperture are excluded (Fig. A).

Illuminating the specimen with high frequency structured illumination, which is multiplied by the unknown structure in the specimen beyond the classical resolution limit, brings the displaced "super-resolution" information within the optical system aperture (Fig. B).

When this "super-resolution" information is then mathematically combined with the standard information captured by the objective lens, it results in resolutions equivalent to those captured with objective lenses with approximately double the NA (Fig. C).

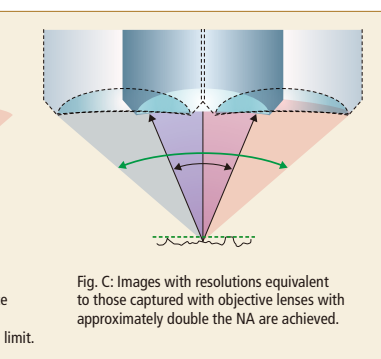
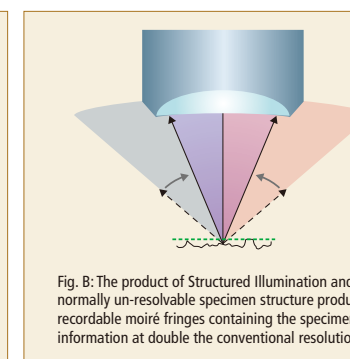
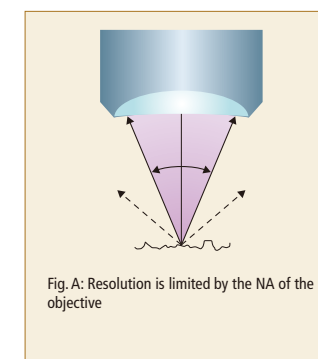

Objectives for super-resolution microscopes

The system can be configured with either a 100X oil immersion type, which is suitable for the imaging of fixed samples, or a 60X water immersion type, which is optimal for time-lapse live-cell imaging. The SR (super resolution) objectives have been designed to provide superb optical performance with Nikon's super-resolution microscopes. The adjustment and inspection of lenses using wavefront aberration measurement have been applied to yield optical performances with the lowest possible asymmetric aberration.



CFI SR HP Apochromat TIRF 100XC Oil
CFI SR Plan Apochromat IR 60XC WI

Auto correction collar (Option)

This unique, auto correction collar with harmonic drive and automatic correction algorithm, enables perfect alignment of the correction collar of AC series objectives, easily and accurately compensating for changes in temperature, deviation of cover glass thickness, or refractive-index distribution in samples.



3-color multi-laser super-resolution capability

The compact LU-N3-SIM laser unit dedicated for N-SIM E is installed with the three most commonly used wavelength lasers (488/561/640), enabling super-high resolution imaging in multiple colors.



LU-N3-SIM laser unit

N-SIM analysis software

Image processing, reconstruction and analysis are carried out using the N-SIM E module that resides within Nikon's universal, cross-platform imaging software NIS-Elements with intuitive, simple operation.

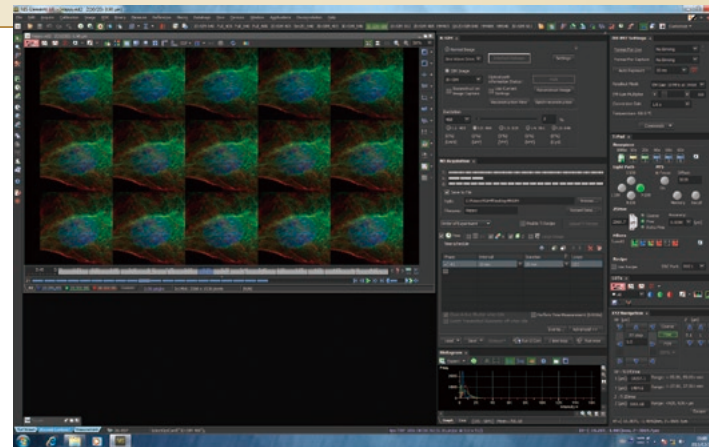

Image acquisition (3D-SIM)

Setting image acquisition

Up to five different laser wavelengths are available. User-customized spectral, z-stack, and time-lapse acquisition settings are automatically managed to allow for a simple workflow from acquisition to image reconstruction. Image reconstruction can be further optimized by modifying reconstruction parameters post-acquisition/offline.

Setting image reconstruction

Auto settings allow the software to automatically select the most appropriate reconstruction parameters for the acquired images. Users can further optimize reconstruction by manually adjusting these parameters.

Reconstruction view

Reconstruction view allows users to preview the results of the selected reconstructed parameters on the current/selected frame, allowing for efficient reconstruction parameter determination.

High-speed reconstruction processing using GPU

High-speed processing using GPU ensures image reconstruction five times faster than that of CPUs, and allows image processing with reduced stress (when using a recommended PC and GPU board).

Specifications

Lateral resolution (FWHM of beads in xy)	115 nm* in 3D-SIM mode
Axial resolution (FWHM of beads in z)	269 nm* in 3D-SIM mode
Image acquisition time	Up to 1 sec/frame (3D-SIM)
Imaging mode	3D-SIM Reconstruction method: slice, stack (option)
Multi-color imaging	Up to 3 colors
Compatible Laser	LU-N3-SIM laser unit 488 nm, 561 nm, 640 nm
Compatible microscope	Motorized inverted microscope ECLIPSE Ti2-E Perfect Focus System Motorized XY stage with encoders Motorized barrier filter wheel Piezo Z stage (option)
Objective	CFI SR HP Plan Apochromat Lambda S 100XC Sil (NA 1.35) CFI SR HP Apochromat TIRF 100XC Oil (NA 1.49) CFI SR HP Apochromat TIRF 100XC Oil (NA 1.49) CFI SR Plan Apochromat IR 60XC WI (NA 1.27) CFI SR Plan Apochromat IR 60XC WI (NA 1.27) CFI Plan Apochromat Lambda 60XC (NA 0.95)** CFI Plan Apochromat Lambda 40XC (NA 0.95)**
Camera	ORCA-Fusion BT camera (Hamamatsu Photonics K.K.)
Software	NIS-Elements AR NIS-Elements C (for Confocal Microscope) Both require additional software modules NIS-A 6D and N-SIM Analysis
Operating conditions	20 °C to 28 °C (± 1.5 °C)

*These values are measured using 100nm diameter beads excited at 488nm.
Actual resolution is dependent on laser wavelength and optical configuration.
** Supports slice reconstruction.

Layout

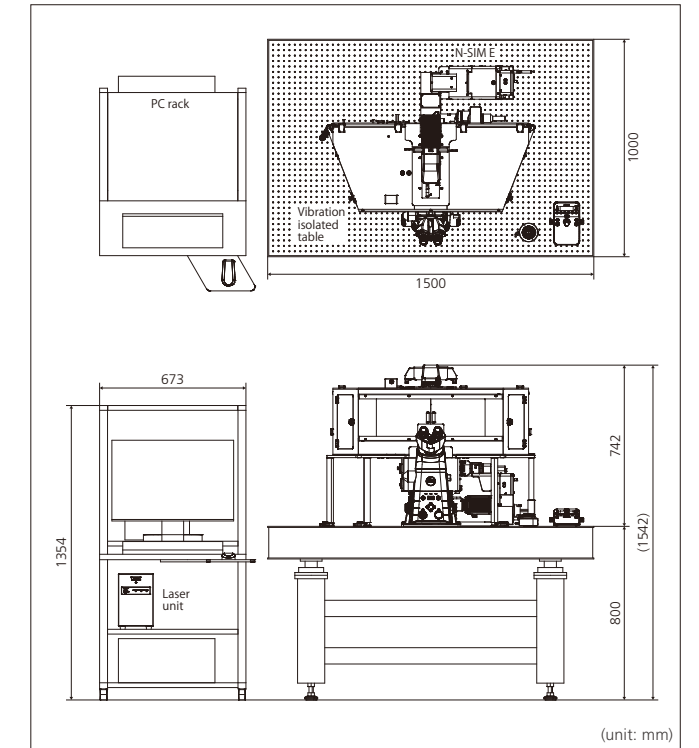

(unit: mm)

System diagram

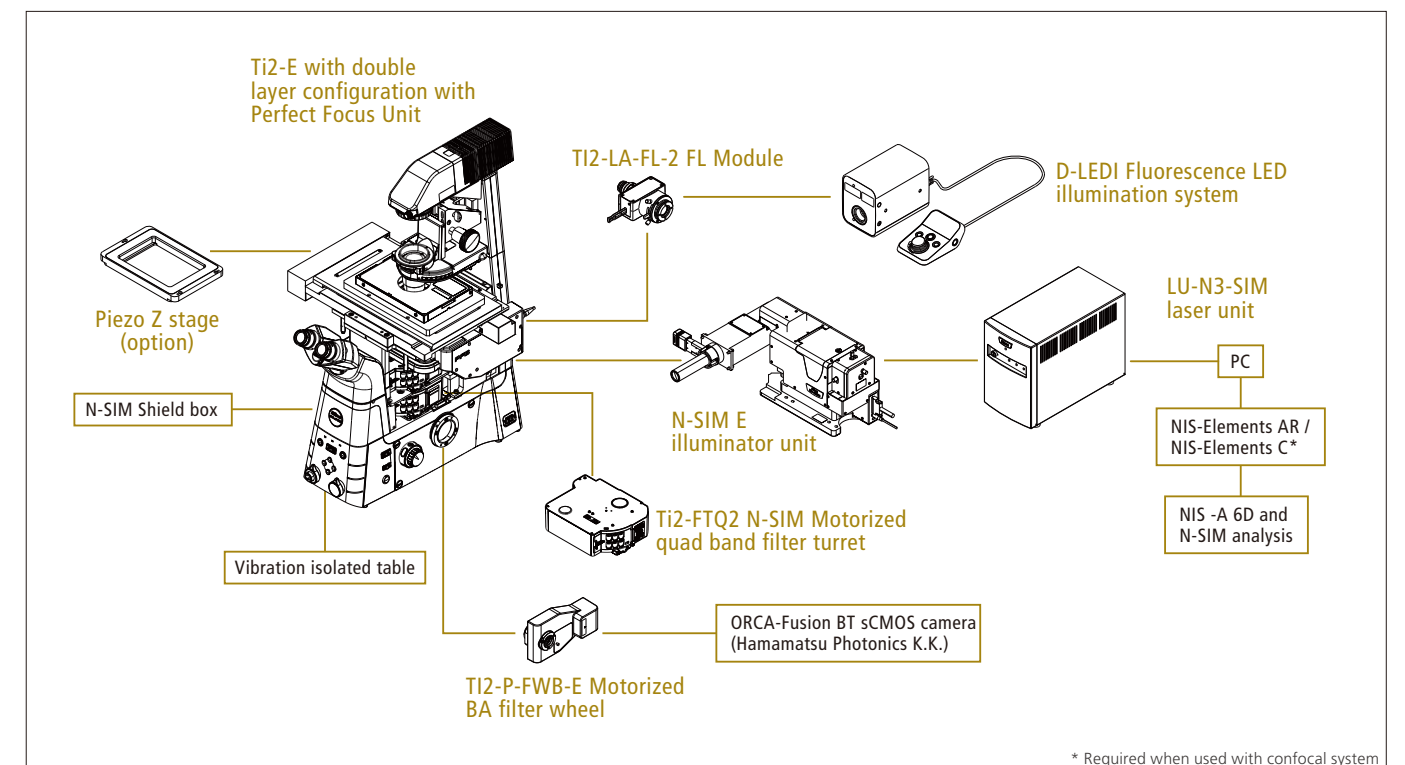

* Required when used with confocal system

Specifications and equipment are subject to change without any notice or obligation on the part of the manufacturer. May 2021 ©2015-21 NIKON CORPORATION

 WARNING	TO ENSURE CORRECT USAGE, READ THE CORRESPONDING MANUALS CAREFULLY BEFORE USING YOUR EQUIPMENT.
---	---

Monitor images are simulated.
Alexa Fluor and Cy are registered trademarks of Thermo Fisher Scientific, Inc.
Company names and product names appearing in this brochure are their registered trademarks or trademarks.
N.B. Export of the products* in this brochure is controlled under the Japanese Foreign Exchange and Foreign Trade Law.
Appropriate export procedure shall be required in case of export from Japan.
*Products: Hardware and its technical information (including software)

WARNING-LASER RADIATION AVOID EXPOSURE TO BEAM CLASS 3B LASER PRODUCT Total Power 500mW MAX. CW 400~700nm IEC/EN60825-1 : 2007, 2014
<small>Complies with FDA performance standards for laser products except for deviations pursuant to Laser Notice No. 50, dated June 24, 2007</small>



NIKON CORPORATION
Shinagawa Intercity Tower C, 2-15-3, Konan, Minato-ku, Tokyo 108-6290, Japan
phone: +81-3-6433-3705 fax: +81-3-6433-3785
<https://www.healthcare.nikon.com/en/>

ISO 14001 Certified
for NIKON CORPORATION



Nikon Instruments Inc.
1300 Walt Whitman Road, Melville, N.Y. 11747-3064, U.S.A.
phone: +1-631-547-8500; +1-800-52-NIKON (within the U.S.A. only)
fax: +1-631-547-0299
<https://www.microscope.healthcare.nikon.com/>

Nikon Europe B.V.
Stroombaan 14, 1181 VX Amstelveen, The Netherlands
phone: +31-20-7099-000 fax: +31-20-7099-298
https://www.microscope.healthcare.nikon.com/en_EU/

Nikon Instruments (Shanghai) Co., Ltd.
CHINA phone: +86-21-6841-2050 fax: +86-21-6841-2060
(Beijing branch) phone: +86-10-5831-2028 fax: +86-10-5831-2026
(Guangzhou branch) phone: +86-2-3882-0551 fax: +86-2-3882-0580
https://www.microscope.healthcare.nikon.com/zh_CN/

Nikon Canada Inc.
CANADA phone: +1-905-625-9910 fax: +1-905-602-9953
Nikon France, Succursale de Nikon Europe B.V.
FRANCE phone: +33-1-4516-4516 fax: +33-1-4516-4505
Nikon Deutschland, Zweigniederlassung der Nikon Europe B.V.
GERMANY phone: +49-211-9414-888 fax: +49-211-9414-322
Nikon Italy, Branch of Nikon Europe B.V.
ITALY phone: +39-055-300-9601 fax: +39-055-300-993
Nikon Europe B.V., Amstelveen, Zweigniederlassung Schweiz (Egg/ZH)
SWITZERLAND phone: +41-43-277-2867 fax: +41-43-277-2861
Nikon UK, Branch of Nikon Europe B.V.
UNITED KINGDOM phone: +44-208-247-1717 fax: +44-208-541-4584

Nikon Österreich, Zweigniederlassung der Nikon Europe B.V.
AUSTRIA phone: +43-1-972-6111 fax: +43-1-972-6111-40
Nikon Singapore Pte. Ltd.
SINGAPORE phone: +65-6559-3651 fax: +65-6559-3668
Nikon Australia Pty Ltd
AUSTRALIA phone: +61-2-8767-6900
Nikon Instruments Korea Co., Ltd.
KOREA phone: +82-2-6288-1900 fax: +82-2-555-4415